

# H4010



## GB | IP-700A GoSmart 7" Video Door Phone Set

---



### Contents

 Safety Instructions and Warnings .....	2
Package Contents .....	3
Technical Specifications .....	3
Device Description .....	4
Installing the Device .....	6
Installing the Application .....	10
Controls and Functions .....	15
Advanced Connection Options .....	21
Troubleshooting FAQ .....	30

## Safety Instructions and Warnings



Read the user manual before using the device.



Follow the safety instructions stated in the manual.

Do not place heavy objects onto the device.

Do not clean the exterior of the device using water or chemicals. Always use a dry cloth to avoid mechanical damage or injury by electric current.

Do not plug the power cable into the socket with wet or moist hands; risk of injury by electric current.

Do not disassemble, repair or modify the device yourself. Doing so may cause a fire, injury by electric current or permanent damage.

EMOS spol. s r.o. hereby declares that radio device type H4010 complies with directive 2014/53/EU. The full wording of the EU declaration of conformity is available at <http://www.emos.eu/download>.

The device can be operated on the basis of general authorization no. V0-R/10/07.2021-8, as amended.





## Package Contents

- Indoor monitor
- Monitor mount
- Camera unit
- Power supply
- Fasteners – screws
- Manual

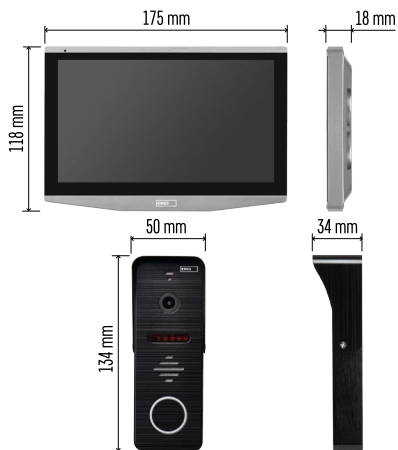
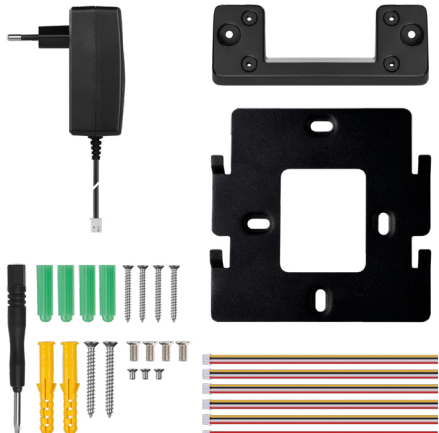

## Technical Specifications

- Screen: 7" IPS
- Resolution: 1080p/960p/720p/480p
- Video formats: AHD/CVI/TVI/CVBS
- Lens angle: 160°
- Storage: SD card (max. 128 Gb, min. Class 10, FAT32), option to expand with cloud storage directly in the EMOS GoSmart app
- Enclosure rating: IP55
- APP: EMOS GoSmart for Android and iOS
- Connection: 2.4 GHz WIFI (IEEE802.11b/g/n)



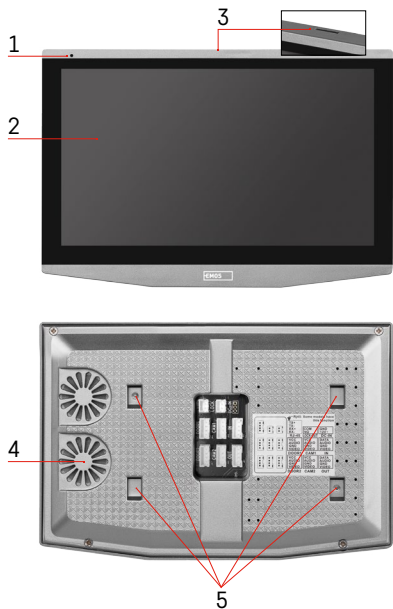

## Device Description

### Description of the Indoor Unit

- 1 – Microphone
- 2 – IPS screen
- 3 – slot for SD card
- 4 – Speaker
- 5 – Anchor points
- 6 – Gate controls
- 7 – Power supply
- 8 – Door unit – Entrance 1
- 9 – External CCTV camera 1
- 10 – Input from the previous monitor
- 11 – Door unit – Entrance 2
- 12 – External CCTV camera 2
- 13 – Output for the next monitor

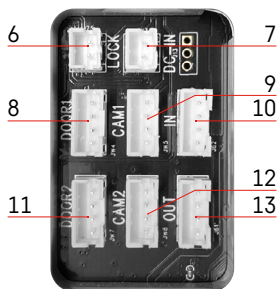

### Description of the Outdoor Unit

- 1 – Microphone
- 2 – Lens
- 3 – IR illumination
- 4 – Speaker
- 5 – Ring button
- 6 – Video mode selector  
Hold the button for 5 s to switch video modes\*. (1080P/720P/CVBS)
- 7 – Button for setting the duration (1–10 s) for opening the door lock
- 8 – Volume setting for the camera unit

*\*If you would like to use an older type of monitor with max. resolution of 720p, you need to use this button to change the quality of the output from the outdoor unit. Otherwise, your monitor will either not display video at all or the image will be cropped.*

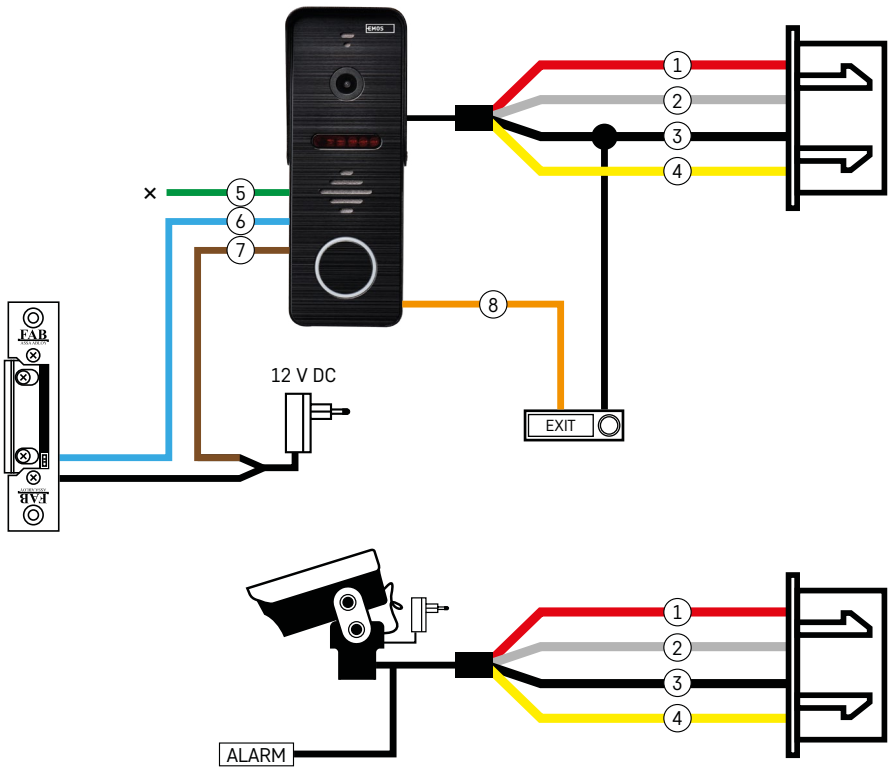

## Description of Wiring

### Door Camera Unit

- 1 – Red – 12 V
- 2 – White – audio
- 3 – Black – GND
- 4 – Yellow – video
- 5 – Green – normally closed (NC) relay contact
- 6 – Blue – common (COM) relay contact
- 7 – Brown – normally open (NO) relay contact
- 8 – Orange – push to exit button (triggered via the GND terminal)

The cables plug into slot DOOR1 or DOOR2.

### External CCTV Camera

- 1 – Red – 12 V
- 2 – White – alarm
- 3 – Black – GND
- 4 – Yellow – video

The cables must be plugged into slot CAM1 or CAM2.



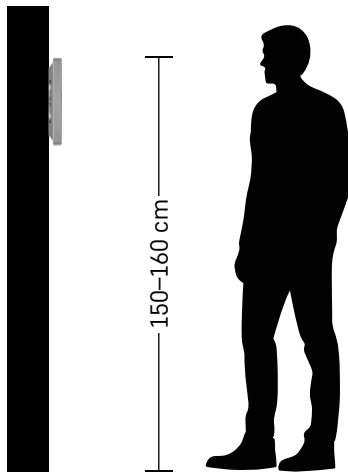
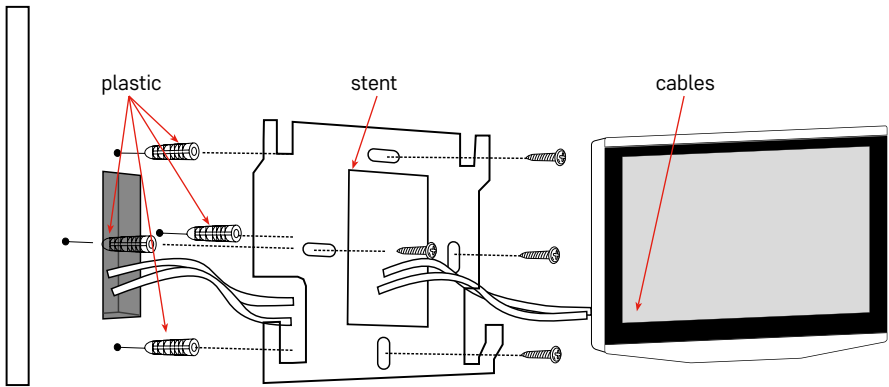

## Installing the Device

### Installing the Monitor

1. Place the mount onto the chosen installation spot.
2. Drill holes to fasten the mount to the wall. Gently press the monitor to the frame so that the protrusions lock into the opening on the back of the monitor. Pushing the monitor slightly downwards will fix it in place. Recommendation: Cable management will be easier if you install junction box A9457 (common number of the product on the EMOS website).

#### Attention:

- Please install at a distance from devices emitting intense radiation: TV, DVR...
- Do not disassemble the device yourself; risk of injury by electric current.
- Be careful not to drop the device, shake it or knock it; you might damage the interior components.
- Choose the best position for installation; optimal mounting height is 150–160 cm.
- Turn off power before installing.
- Mount the device at a minimum distance of 30 cm from 230 V cabling, otherwise, there might be audio and video distortion caused by the 50 Hz power line frequency.
- Mount away from water, magnetic fields and chemicals.

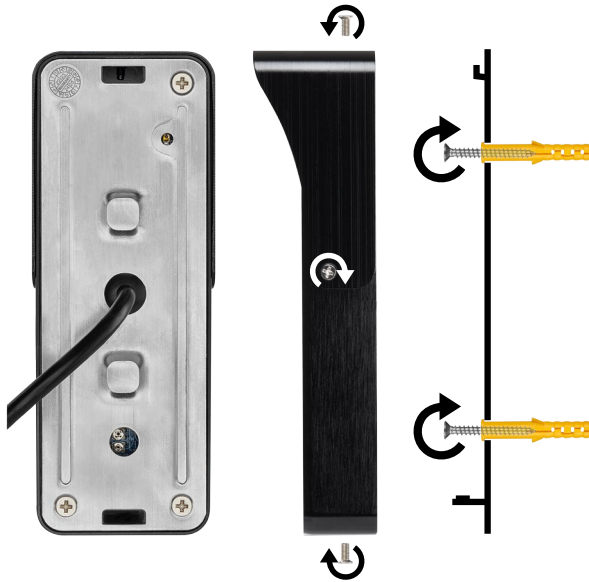
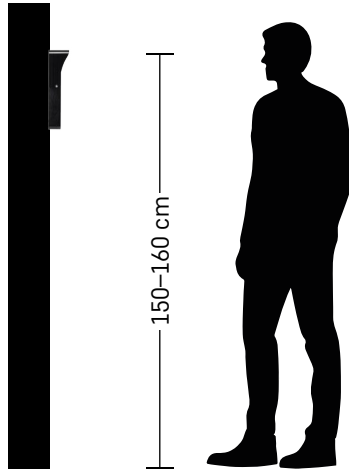

### Installing the Indoor Unit

1. Choose a suitable mounting spot and attach the mounting frame.
2. Pull the power supply cable through the mounting opening and connect it to the terminal on the back of the door camera unit.
3. Mount the connected door camera unit onto the mounting frame using the enclosed screws.
4. Apply a layer of silicone between the wall and the door camera unit to prevent ingress of humidity under the door camera unit. The silicone should be applied on the top and the sides. The bottom side must be left open to allow humid air to exit the space under the door camera unit.

## Setting Volume and Unlock Duration

- 1 – Button for setting the duration (1–10 s) for opening the door lock
- 2 – Setting Volume for the Camera Unit

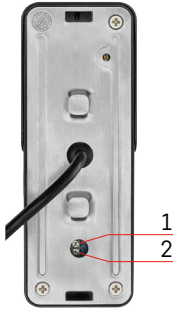

- If you find the door unlock time unsuitable and would like to extend or shorten it, you can do so using the potentiometer hidden on the back of the outdoor unit under a rubber insert. Use a very thin screwdriver to CAREFULLY turn the potentiometer right or left.
  - Right = increase unlock time
  - Left = reduce unlock time
- You can use the same method to adjust the volume of the outdoor unit using the potentiometer at the bottom.



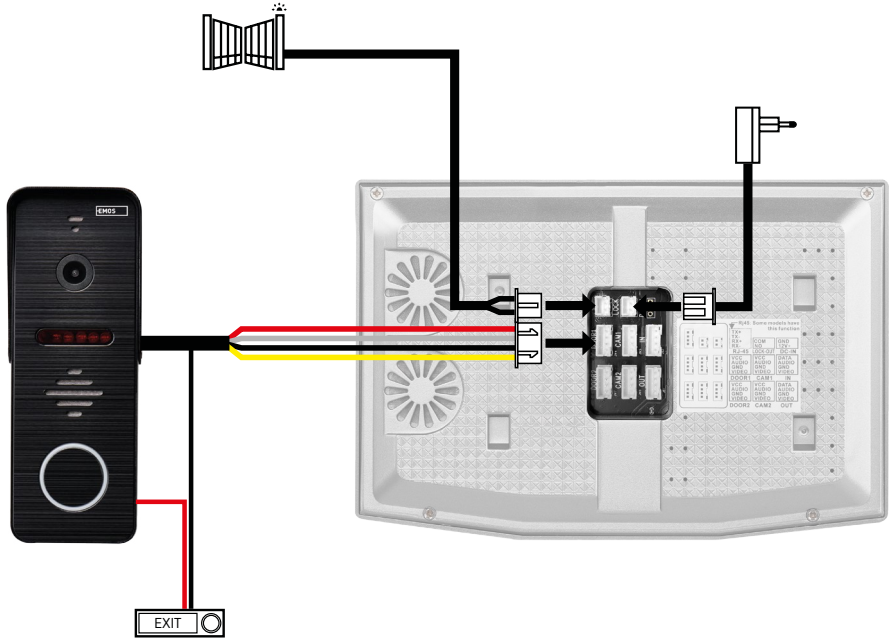
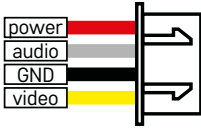
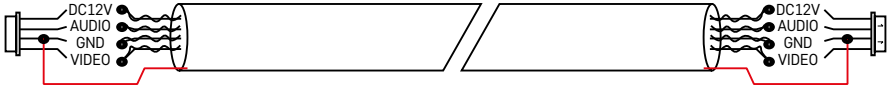

## Connecting Cabling

When using a CAT5 or CAT6 network cable, the effective distance from the outdoor camera to the farthest outdoor monitor will be limited. If using an unshielded network cable, the maximum distance is 20 m. For a shielded network cable, the maximum distance is 40 m.

A CAT5 or CAT6 network cable consists of 4 twisted pairs (8 wires); here, one pair of twisted wires will be used as one cable. Green/White+Green, Brown/White+Brown, Orange/White+Orange, Blue/White+Blue. If you want to extend the distance to more than 60 m, it is best to use a shielded cable with a thick copper core. Connect the shielding on both ends to the GND terminal (Black conductor).

For longer distances, we recommend using a SYKFY cable.

It is recommended to always place the cable used for communication between the outdoor camera unit and the indoor monitor in a PVC cable duct. The connecting cable must never lead alongside power lines or pass through the power section of the electrical cabinet.



## Installing the Application

### Starting the System – EZ mode

Step 1:

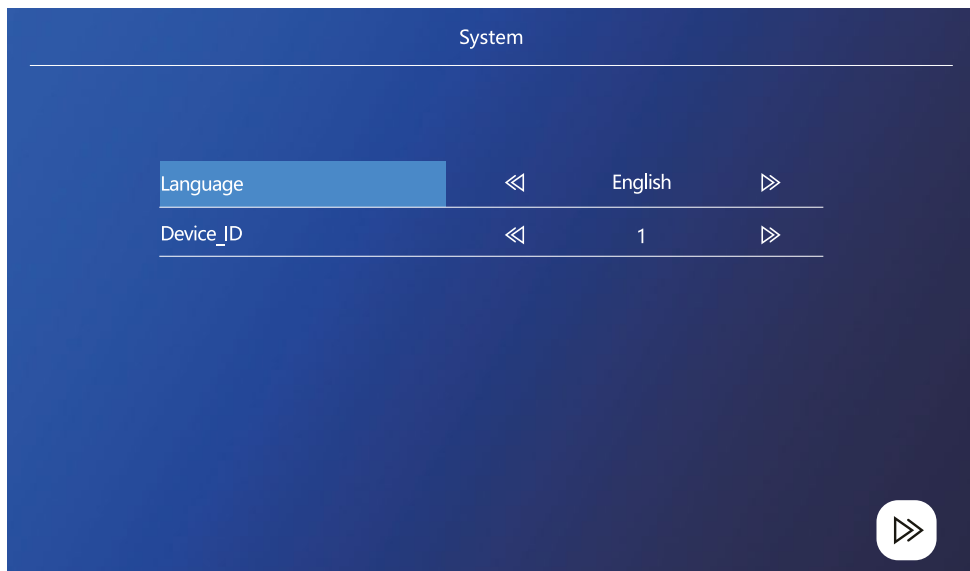

Device ID is an important part of configuring the device in the system. Without the correct ID configuration the device will not work properly. If the current MASTER device is connected to outdoor unit 1, its ID must be set as 1 and the other SLAVE monitors must be set to 2/3/4/5/6 in order for everything to work correctly.

**Step 2:**

Input setting

---

Door1 Signal mode	◀	PAL	▶
Door1 Signal type	◀	AHD1080	▶
Door2 Signal mode	◀	PAL	▶
Door2 Signal type	◀	AHD1080	▶
Camera1 Signal mode	◀	PAL	▶
Camera1 Signal type	◀	AHD1080	▶
Camera2 Signal mode	◀	PAL	▶
Camera2 Signal type	◀	AHD1080	▶

Quick setup: ◀▶

The input video signal must be set correctly, otherwise the image will not display properly. If you are using the original outdoor unit included with the main unit, leave the signal mode set to PAL and its type set to AHD1080. If you are using a different device or are unsure about resolution, you can use the automatic detection feature. You can tell that the signal type and mode has been set incorrectly if the video image is blurry/incomplete/cropped, or does not display at all.

**Step 3:**

Network Setting

---

Netpairing Mode	◀	EZ Mode	▶
Cloud services	Unconnected		
IP address			
MAC	44:01:bb:xx:xx:xx		
UUID	*CVBFX02***		

◀▶

# Steps on the phone

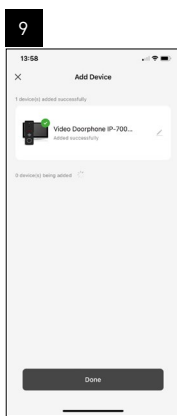
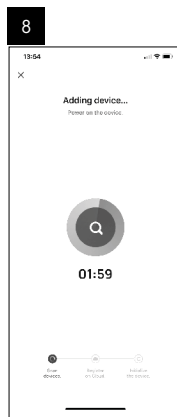
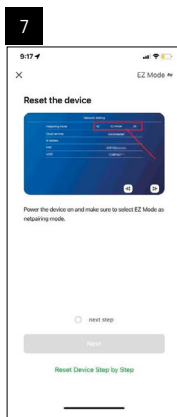
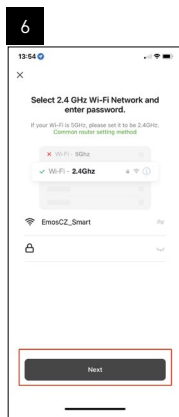
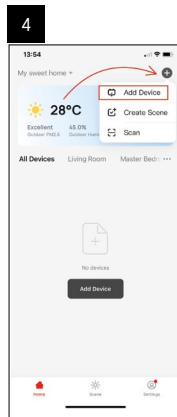
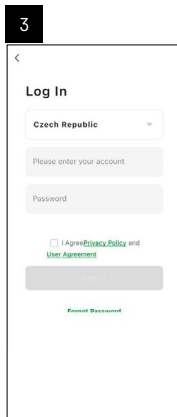
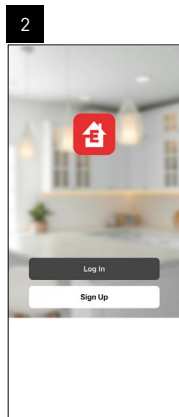
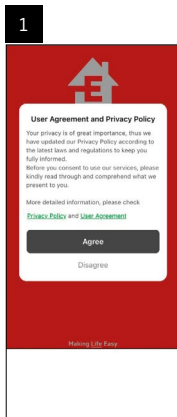

## Starting the System – AP Mode

If you have been unsuccessful in pairing the device using EZ mode, you can also pair it using AP mode. In AP mode, the device creates its own Wi-Fi hotspot, which you can then connect to using your phone and pair the device that way.

Repeat steps 1 and 2 like when pairing using EZ mode, then switch mode from EZ to AP in step 3. After setting AP mode, restart the device. The system will restart after you click the confirmation icon (👤).

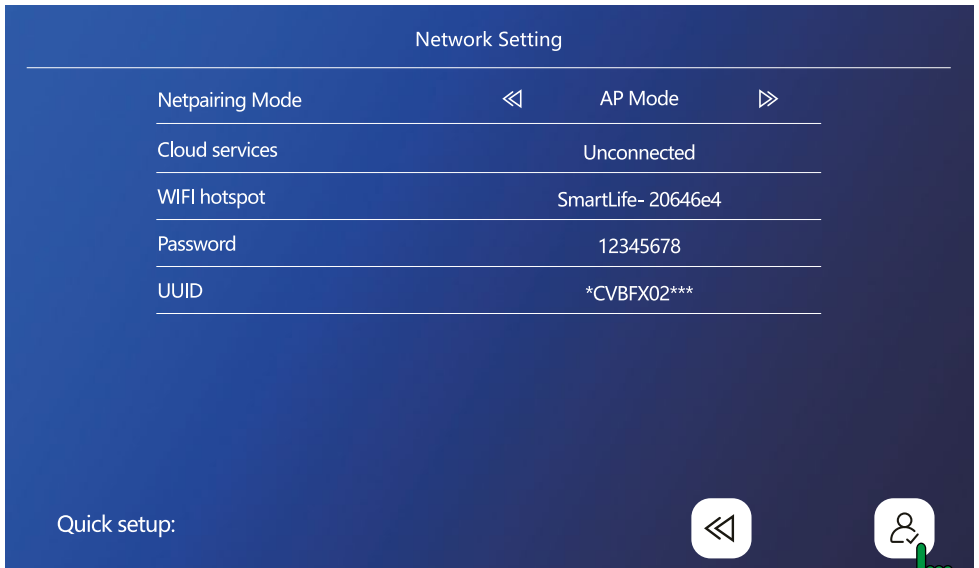
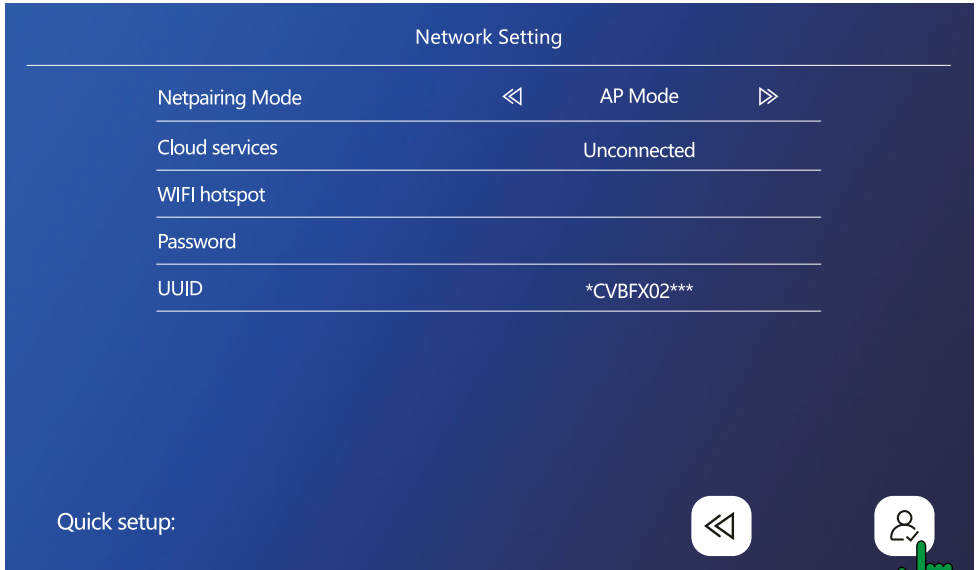

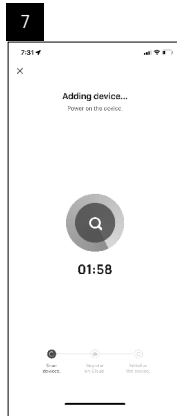
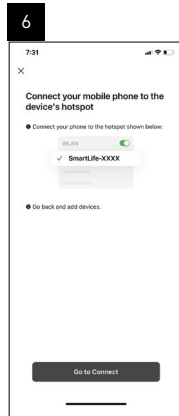
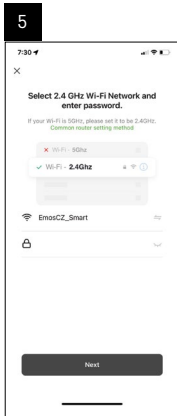
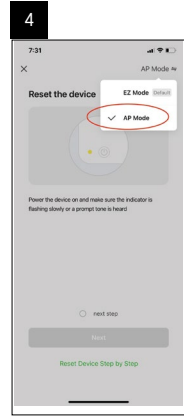
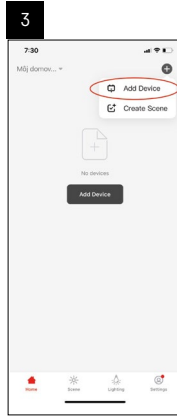
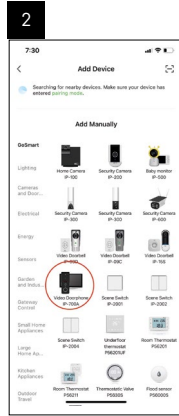
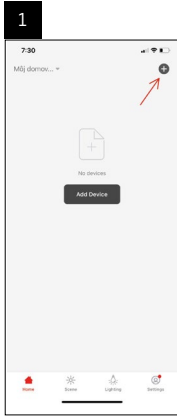

In step **6** connect your mobile phone to the Wi-Fi network broadcast directly from device H4010; the network name will be SmartLife-XXXX. The password for the network is stated on the monitor when selecting AP pairing mode. The default password is 12345678.



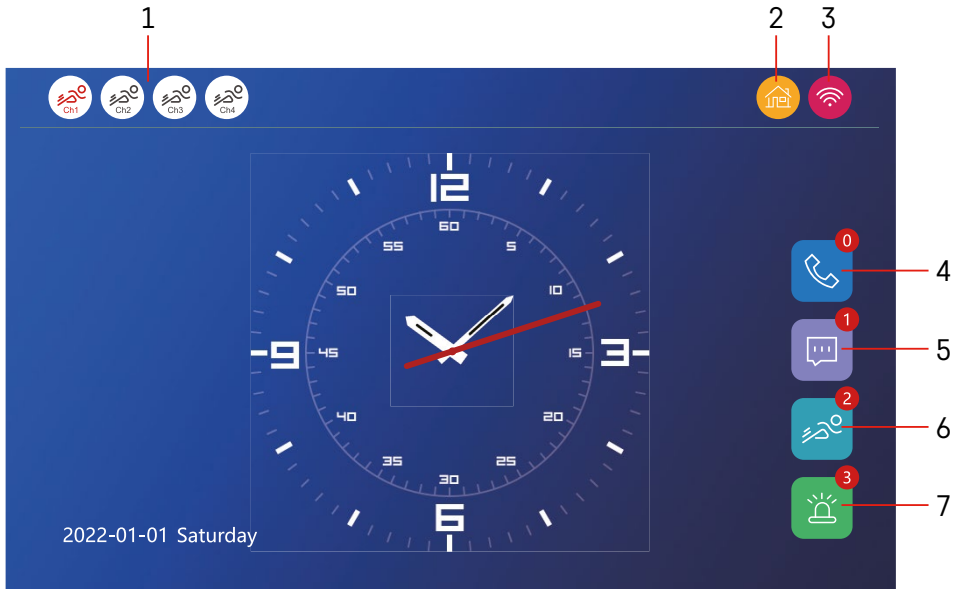

## Controls and Functions

### Description of Icons on the Home Screen

#### 1 – Motion detection on individual channels



Red colour indicates that detection is active; if the icon is grey, it means the motion detection is turned off for the camera.

#### 2 – Switching modes:



„Home“ – Normal operation. Notifications are also sent to the phone.



„Away“ – Visitors can record a video message. It will then also be sent to the phone.



„Do not disturb“ – The indoor and outdoor unit will not ring, a notification will be sent to the phone.

#### 3 – Network connection status indicator



#### 4 – Call records









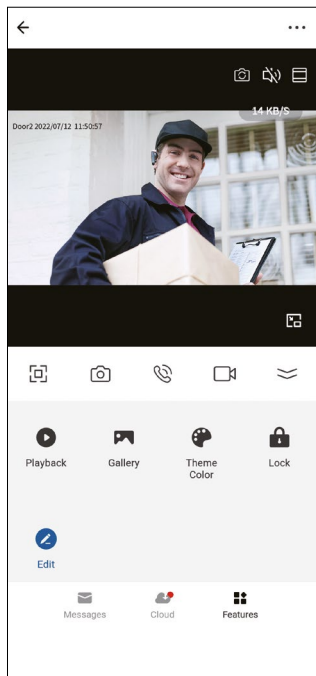



#### 5 – Files with message records

#### 6 – Motion detection records

#### 7 – Alarm records

## Description of Icons in the Application



	Channel switching
	Mute
	Zoom
	Fullscreen mode
	Take pictures using the app and save them in the mobile album
	Speak
	Capture video using the app and save it in the mobile album
	Play video stored on the SD card
	View videos and photos taken through the app
	Light mode / dark mode
	Open the lock
	Cloud service for saving videos from calls and videos from motion detection



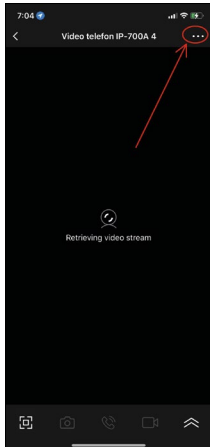

## Advanced Device Settings in the App

You can view additional setting options by tapping the 3 dots in the top right corner.

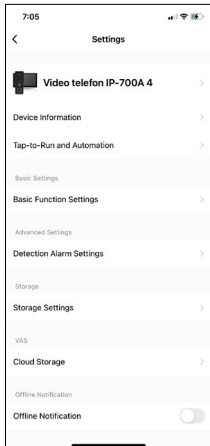

- **Device information** – Basic information about the device and its owner
- **Tap-to-Run and Automation** – View scenes and automations assigned to the device. Scenes can be created directly in the app's main menu in the Scenes section. For H4010 you can, for instance, create automation that will reduce the sensitivity of the camera unit's motion detection from 18:00 to 7:00.
- **Basic Function Settings** – Option to turn on/off basic functions of the device such as status indicator, automatic screen rotation or watermark with time and date.
- **Detection Alarm Settings** – Settings for alarm sensitivity.
- **Storage Settings** – Shows space remaining on the SD card and its formatting options
- **Cloud Storage** – Option to buy cloud IPC storage for alarm recordings.
- **Offline Notification** – The app will send a notification in case the indoor monitor encounters issues with connection to the network.

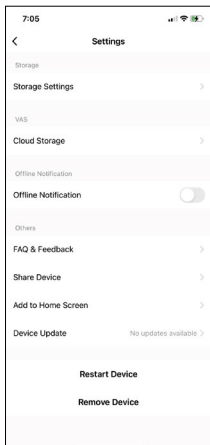

- **FAQ & Feedback** – Shows frequently asked questions and their solutions and provides the option to send us question/suggestion/feedback directly
- **Share Device** – Option for sharing the device with another user.
- **Add to Home Screen** – Adds an icon to the home screen of your phone. That way, you no longer need to open the device through the app; you simply tap the newly added icon, and you will be redirected straight to the camera view.
- **Device update** – Update the device. Option to turn on automatic updates.
- **Restart Device** – Restart the device.
- **Remove Device** – Remove and unpair the device. An important step if you wish to change the owner of the device. Once the device is added to the app, the device is paired with the account in the app and cannot be added to another account without unpairing.

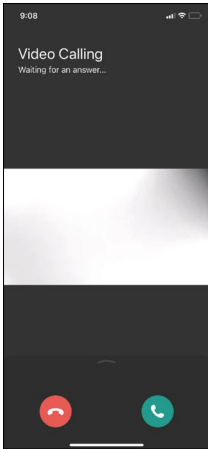

## Description of Icons in the Application during a Call

These icons are used if you answer a call to the device through your phone.

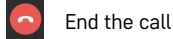

End the call



Answer the call

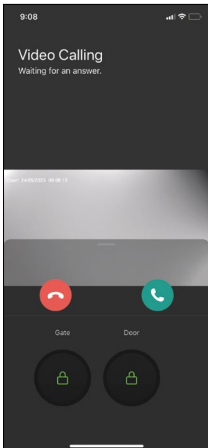

If you wish to unlock the gate or door without having to answer the call, slide your finger up in the menu. You will see 2 additional icons which will allow you to unlock the door or gate.



Unlock the gate



Unlock the door

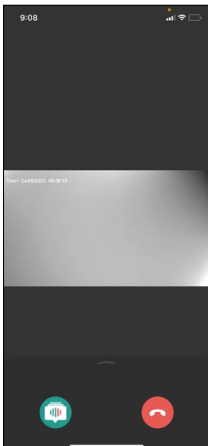

The next screen appears after answering a call.

**Voice changer** – Safety feature. If you're in a situation where you do not want to answer a call using your normal voice, you can use the voice changer to change your voice to female/male/filtered...



Voice changer



End the call

## Main Menu Styles

Here you can choose from 3 different graphical styles for the monitor's main menu.

### Android menu:

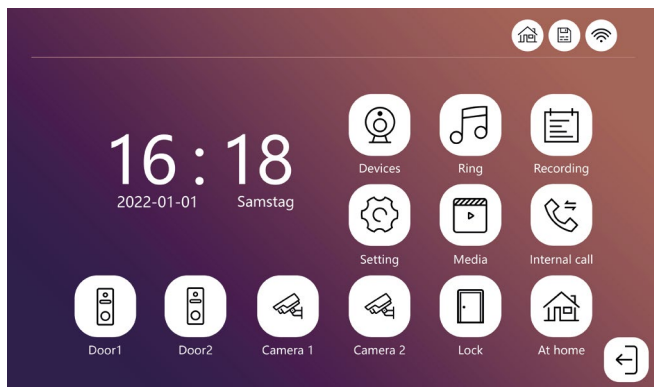

### Standard menu:



### Windows menu:

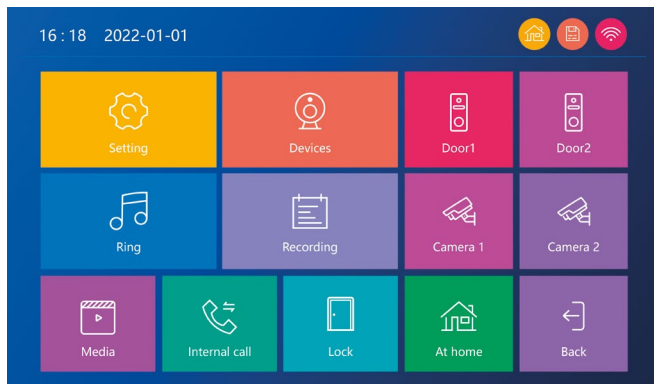

## Description of Main Menu Icons

	System settings
	Settings for device parameters (E.g. gate unlock duration)
	Ringtone settings
	Play back recordings
	Play multi-media files
	Intercom
	Unlock the door
	"Home" mode
	"Away" mode
	"Do not disturb" mode
	Outdoor camera unit
	Security camera

### Intercom Function

The intercom function allows you to communicate between interconnected indoor units.

Simply tap the intercom icon  in the menu and select which indoor unit you wish to communicate with.



## Advanced Connection Options

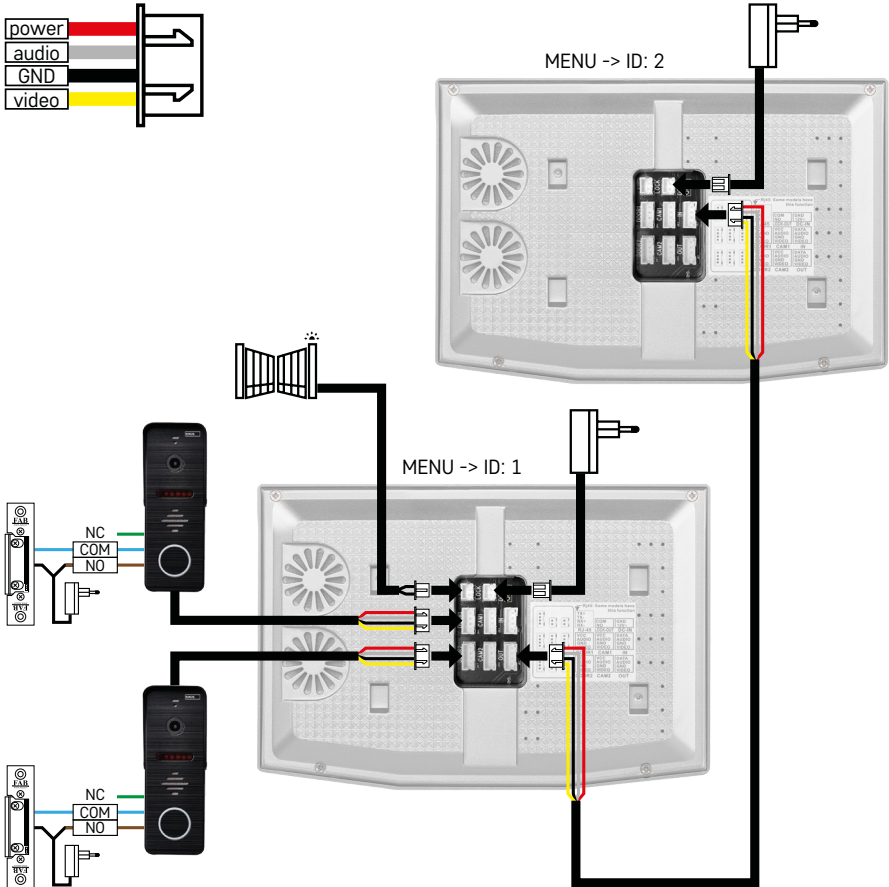

Connection of 2 independent entrances and an intercom for a single housing unit.

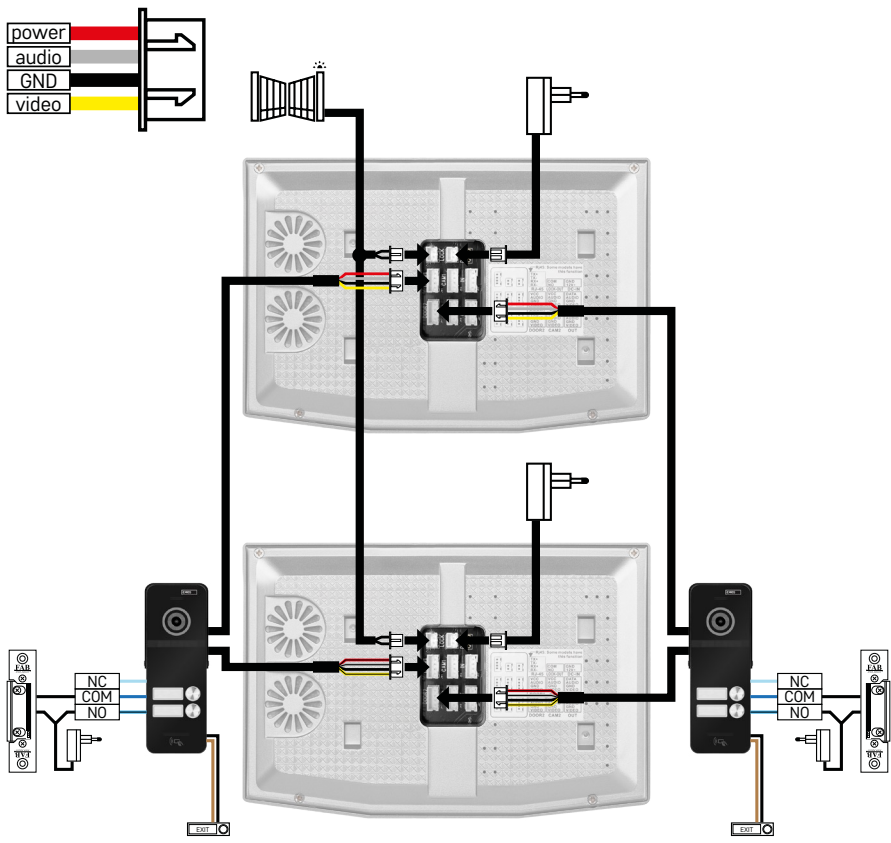

Connection of 2 independent entrances for 2 independent housing units.

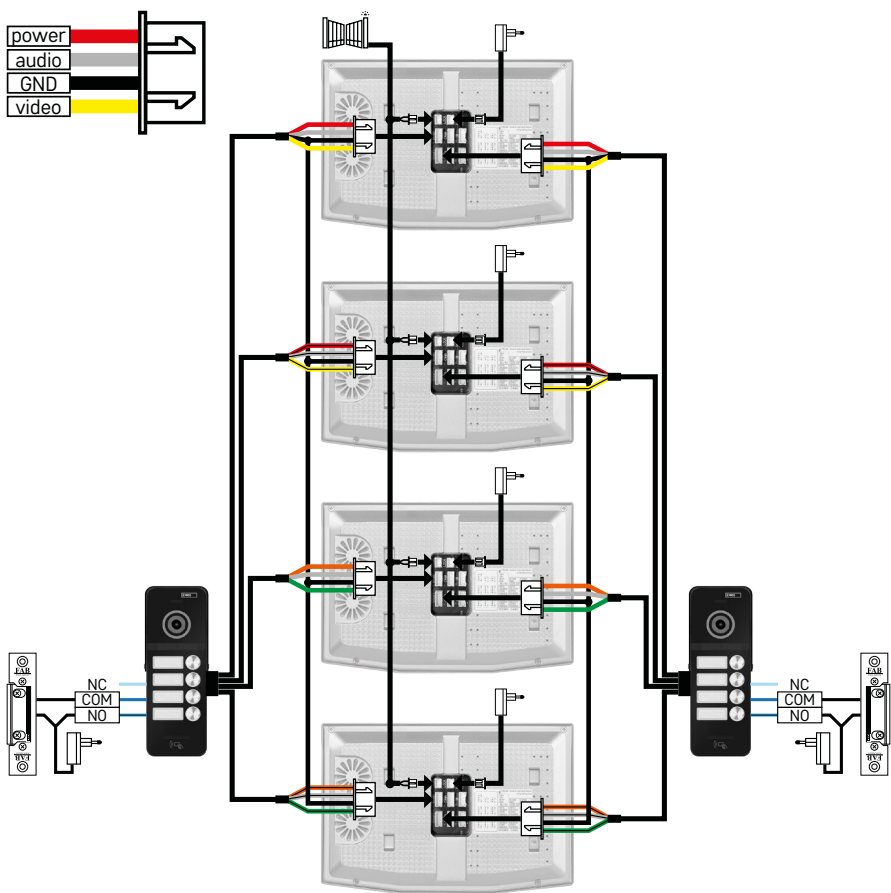

Connection of 2 independent entrances for 4 independent housing units.

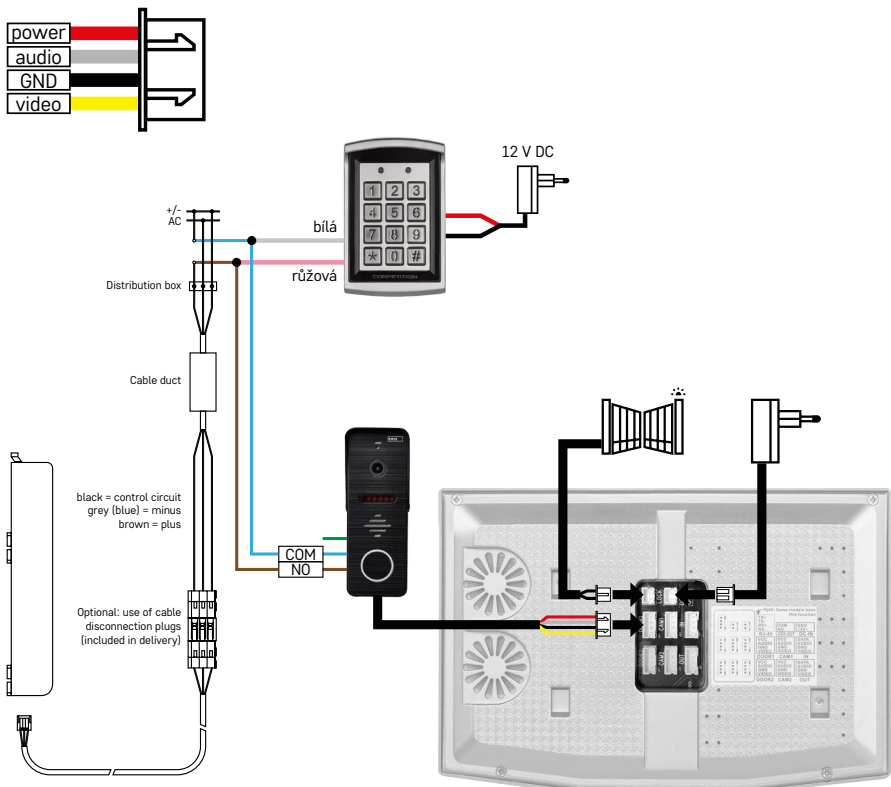

Connection of a single housing unit with a single independent entrance in combination with a H8011 keypad and G.U-SECURITY lock.



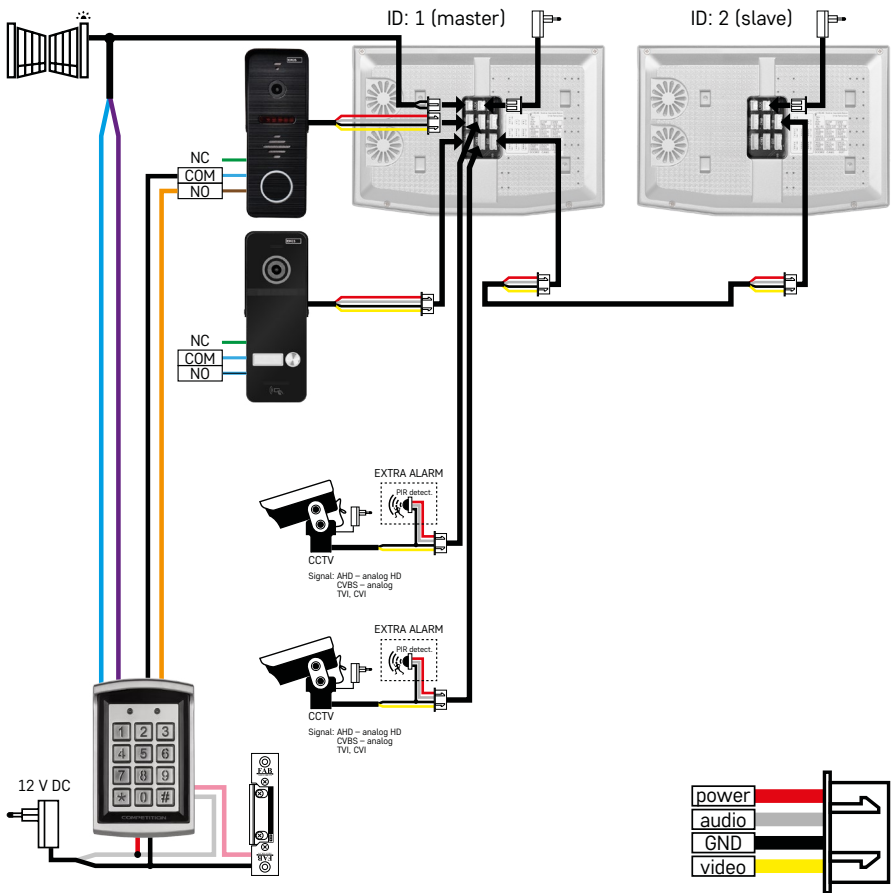

Connection of 2 independent entrances with a H8011 keypad and CCTV cameras for a single housing unit with intercom.

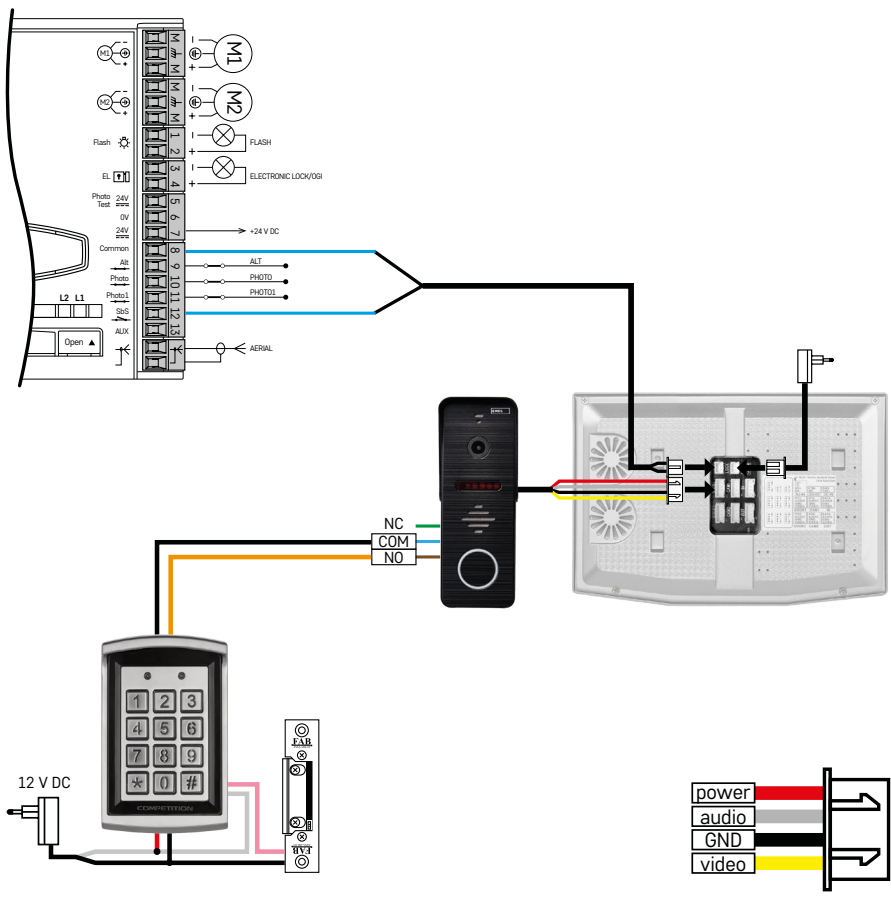

Connection of a single independent entrance in combination with a H8011 keypad and a WINGO NICE 2024 KCE gate drive for a single independent housing unit.

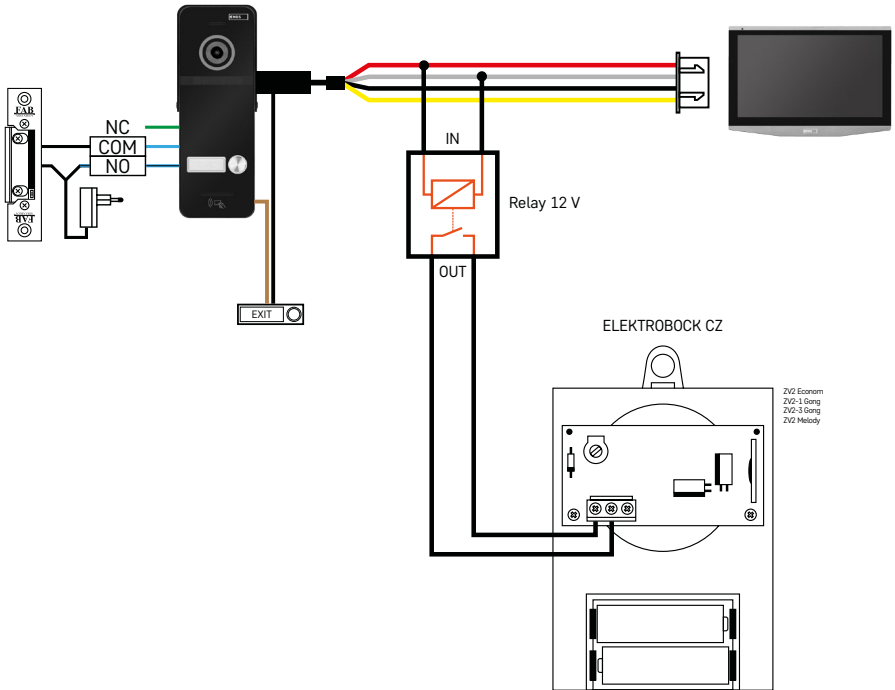
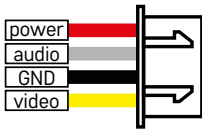

Connection of a single independent entrance with a push to exit button and an additional ELEKTROBOCK ZV2 indoor bell for a single independent housing unit.

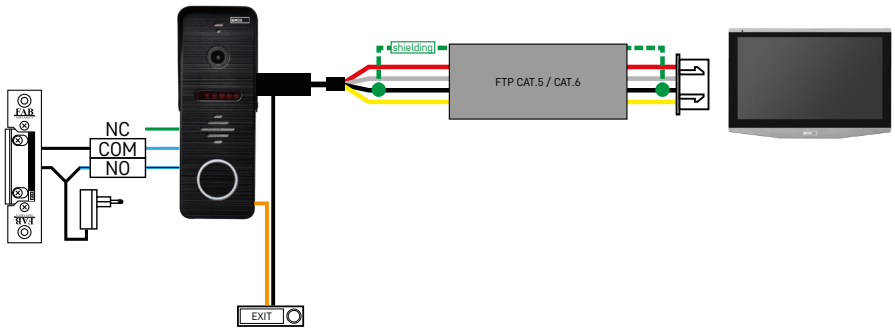
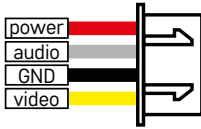

Connection of a single independent entrance with a push to exit button for a single independent housing unit. Interconnection using an FTP cable. Bilateral shielding connected to GND.

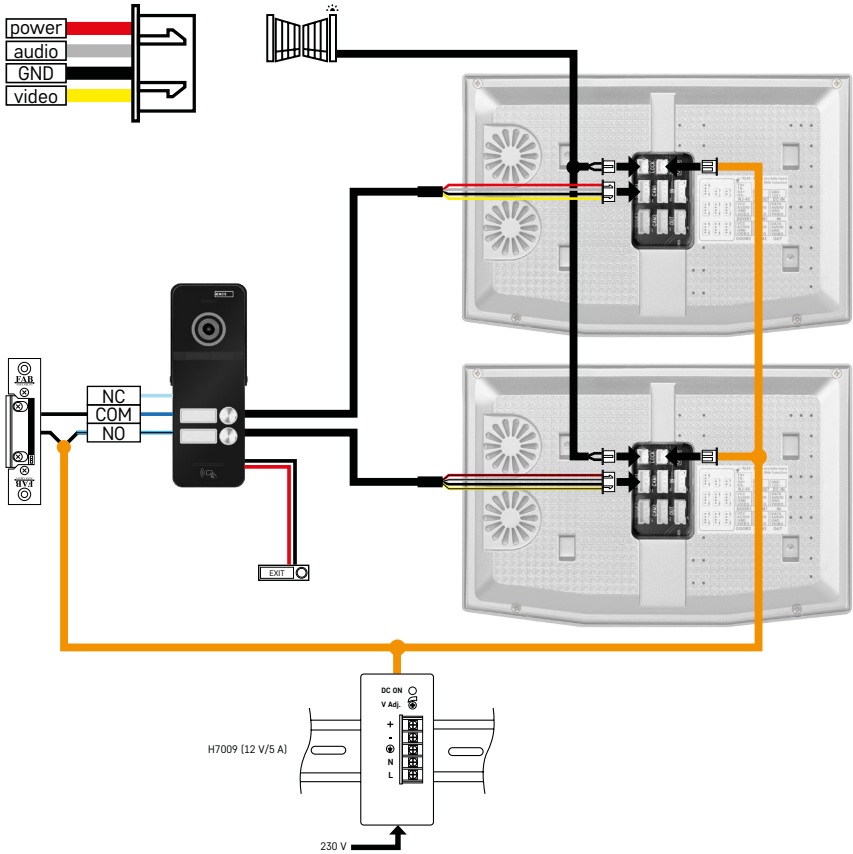

Connection of a single independent entrance with a push to exit button for 2 independent housing units. Powered via a H7009 DIN-rail power supply mounted in the electrical cabinet.

**ATTENTION:** Do not interconnect master monitors with one another. If you have an outdoor unit for two or more users and you interconnect the master monitors with one another, pressing any doorbell button will make all the connected monitors ring. For that reason, it is important to separate master monitors and only interconnect master monitors with slave monitors. This connection will also enable you to use the intercom feature between the units.

*Practical example:* The device is being installed into a house with 2 independent two-storey flats. There is only one entrance, so you install an outdoor unit with two users. Each flat has a master monitor on the ground floor and a slave monitor on the 1st floor. Pressing doorbell A will ring the master and slave monitor in flat A. Pressing doorbell B will ring the units in flat B. The intercom function allows a user on the top floor of flat A to call the bottom floor of flat A. The same applies inside flat B. But there is no way to make a call between flats A and B.

With an incorrect connection, where the master monitors of flat A and flat B are interconnected, pressing any doorbell button would ring all the monitors in both flat A and flat B.



## Troubleshooting FAQ

### The devices are not pairing.

- If you are having trouble pairing the devices, first try resetting the monitor to factory settings two or three times (Settings -> factory settings -> OK).
- Make sure you are using a 2.4 GHz Wi-Fi network.
- Give the app all permissions in the phone's settings.
- Check that you are using an up-to-date version of the mobile operating system and the latest version of the app.
- If even these steps do not solve the issue, try pairing using AP mode, which is described in detail above in the manual.

### Notifications are not working, why?

- Give the app all permissions in the app's settings on the phone.
- Turn on notifications in the app's settings (Settings -> App notifications).
- Make sure that "Do not disturb" mode is not active in notification settings.

### How can I power the whole system?

- The package includes an original power supply.
- You can use our H7009 DIN-rail power supply which can power up to 3 monitors and 1 lock.

### What do I use to interconnect the monitor with the outdoor unit?

- The outdoor and indoor units must be interconnected using a high-quality shielded cable of at least CAT.5
- For longer distances (over 50 m), we recommend using a SYKFY cable.
- For more information, check the Connecting Cabling chapter above.

### I need to connect an outdoor lock. How do I do that?

- The lock must be connected to the outdoor unit.
- It must be powered separately by 12 V.

### The lock opens only very briefly. Is it possible to extend the interval?

- Yes, you will find more information in the Setting Volume... chapter above.
- ATTENTION! Only turn the control potentiometer very carefully; rough handling of the potentiometer could irreversibly damage the device.

### What SD card can I use?

- The SD card must have a maximum storage capacity of 128 Gb and minimum speed of CLASS 10

### I have 2 entrances; can I have 2 outdoor units?

- Yes, the device supports a maximum of 2 entrance units.

### How many indoor units can I have?

- Each master monitor supports the connection of up to 5 slave monitors.
- It is very important to set the correct device ID for the monitors. The master monitor must have an ID of 1 and the slave monitors 2 to 6.
- For example, if you have an outdoor unit with 4 doorbell buttons (names), you can connect up to 4 master monitors to it, each of which can then have another 5 slave monitors.

### How many CCTV cameras can I connect?

- 2

### The sound crackles/hums and the video have poor quality or has lines running across it. What is wrong?

- The device has been mounted using unshielded cables, or the cables run alongside power lines.
- The issue can be solved by using a quality shielded cable and connect the shielding to terminals no. 2.
- When routing the connecting cable between the indoor and outdoor unit, maintain a minimum distance of 30 cm from 230 V AC cabling.

### How many languages does the monitor support?

- The monitor supports up to 8 languages. (English, Czech, German, French, Spanish, Polish, Italian, Russian)
- The app language is set automatically to the language of your phone.

**Is it possible to connect an RFID reader from the other side as exit authentication?**

- A push to exit button located on the inside by the door would be sufficient in that case. Or you can buy a H8011 keypad (must be connected to power); adapter for it is not included.

**When the SD card's memory is full, are the oldest recordings automatically overwritten or do I have to delete them manually?**

- Yes, recordings are overwritten automatically.

**Who is allowed to use the device?**

- The device must always have an Administrator (owner).
- The Administrator can then share the device with the other members of the household and assign them rights, see Advanced Device Settings in the App.



